

#	ITEM	QTY.	DESCRIPTION	DET	PART #	WT
---	------	------	-------------	-----	--------	----

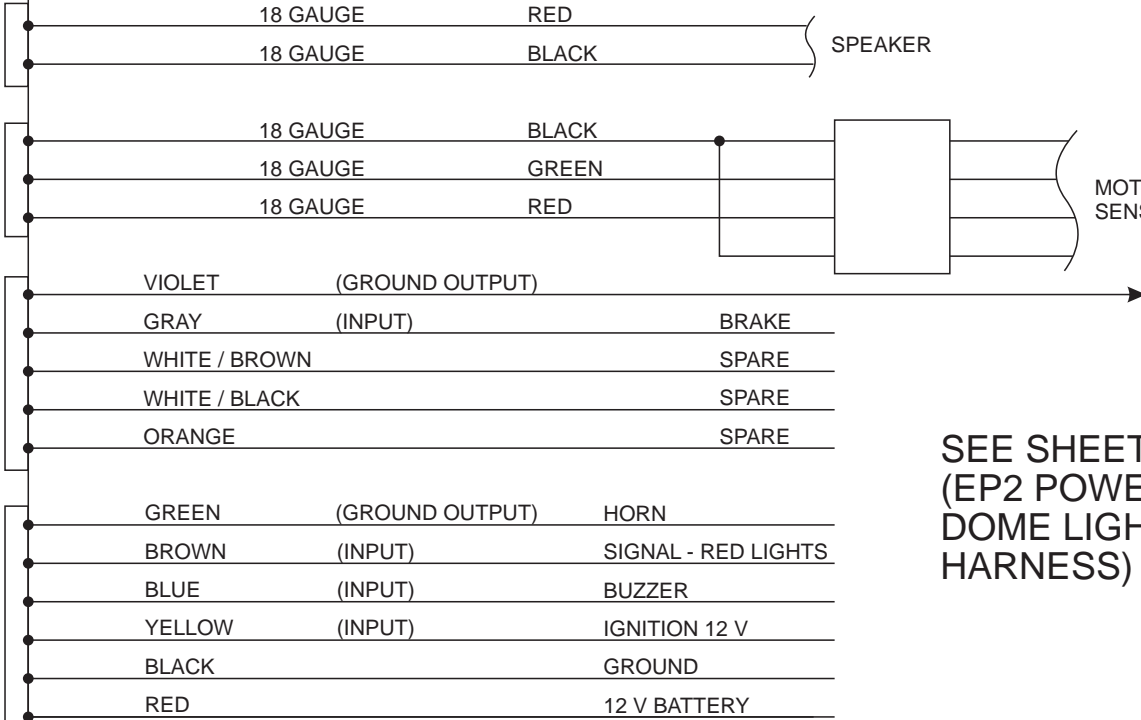
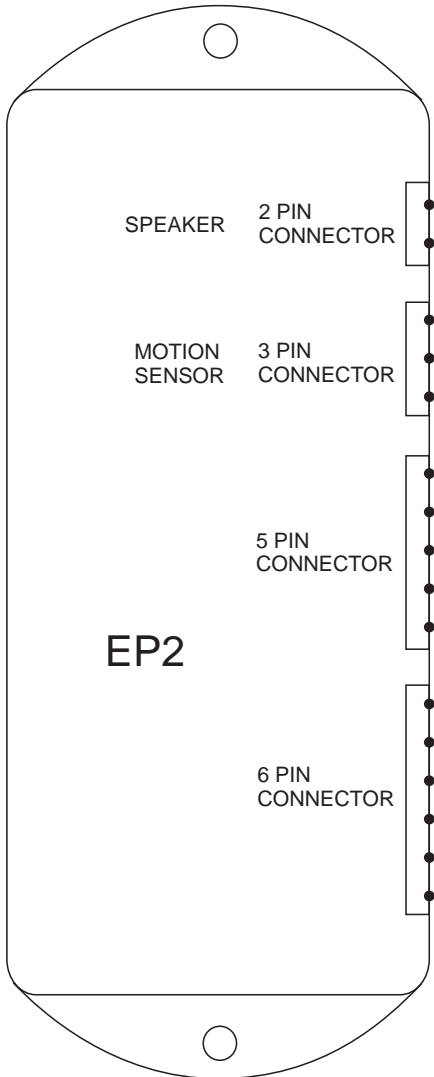

SEE SHEET 3
(SENSOR HARNESS
WIRING SCHEMATIC)

SEE SHEET 2
(EP2 POWER AND
DOME LIGHT
HARNESS)

A	RELEASED					
NO.	REVISION	ECN	BY	DATE	CHK.	APP.

NOTE: TOLERANCES UNLESS OTHERWISE SPECIFIED
 FOR ANGULAR DIMENSIONS ± 0° 30'
 FOR DECIMAL DIMENSIONS X.XXX ± 0.005"
 FOR DECIMAL DIMENSIONS X.XX ± 0.010"
 FOR HOLE LOCATIONS ± 1/32"
 FOR OTHER DIMENSIONS ± 1/16"
 ARE TO BE NON-CUMULATIVE



Child Check-Mate Systems Inc.

EP2

ALL OF THE INFORMATION CONTAINED ON THIS DOCUMENT IS THE EXCLUSIVE CONFIDENTIAL PROPERTY OF THE CHILD CHECK-MATE CORPORATION. THIS DOCUMENT IS DISCLOSED WITH THE UNDERSTANDING THAT IT WILL BE RETAINED IN CONFIDENCE, AND RETURNED UPON DEMAND. IT IS NOT TO BE DUPLICATED, COPIED REPRODUCED OR DELIVERED TO OTHERS, IN WHOLE OR IN PART. NOR IS THE PROPRIETARY INFORMATION CONTAINED HEREIN TO BE USED FOR ANY PURPOSE OTHER THAN THAT FOR WHICH IT IS BEING DISCLOSED.

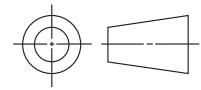

THIRD ANGLE PROJECTION

DRAWN BY:	WHT
CAD DISC FILE:	
LAST DISC REV.:	
LAST PLOT DATE:	
SCALE	PLOT SCALE

PROJ. NO.	
-----------	--

DWG. NO.		SHEET 1 OF 3	REV. 01
----------	--	--------------	---------

#	ITEM	QTY.	DESCRIPTION	DET	PART #	WT
---	------	------	-------------	-----	--------	----

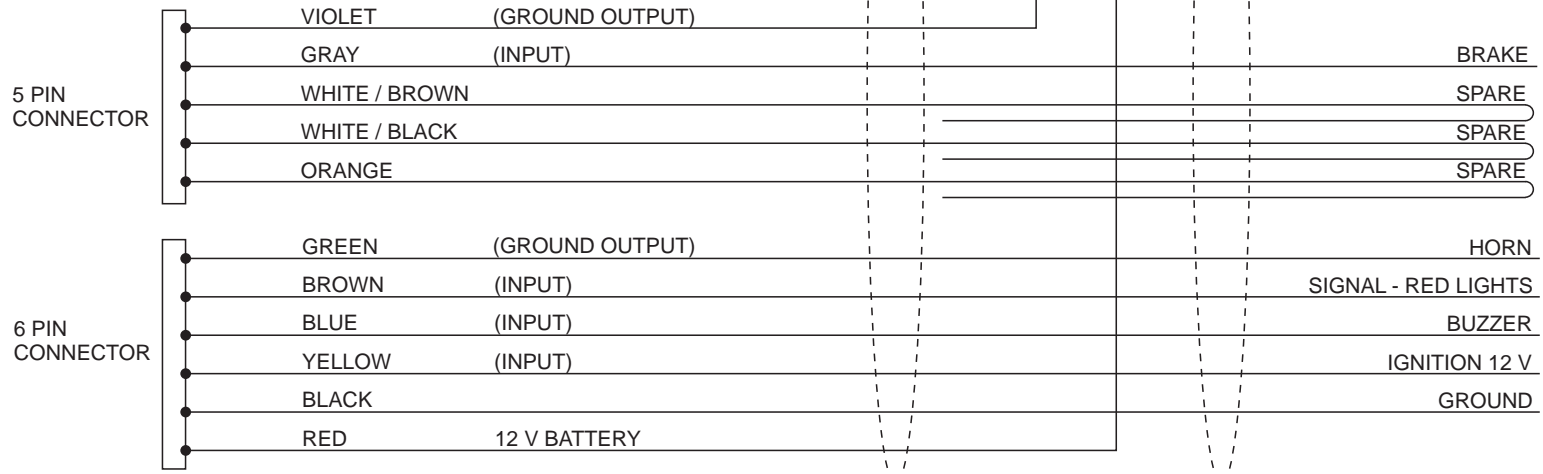
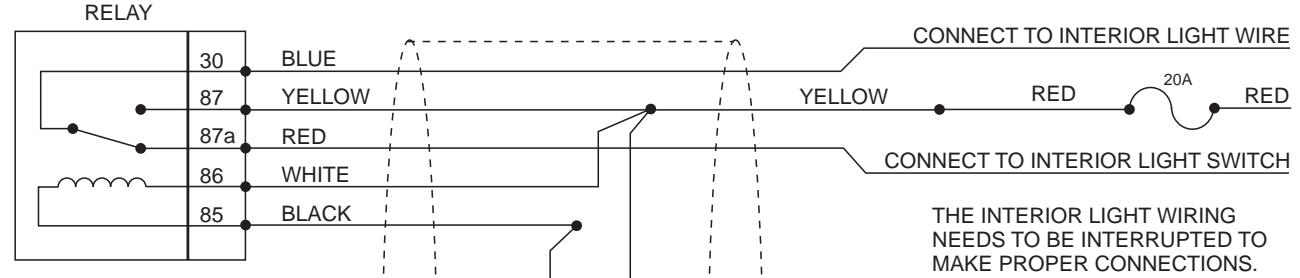

FOLD SPARE WIRES BACK ON THEMSELVES SO THE ENDS ARE HELD BY THE HEAT SHRINK.

HEAT SHRINK TUBING

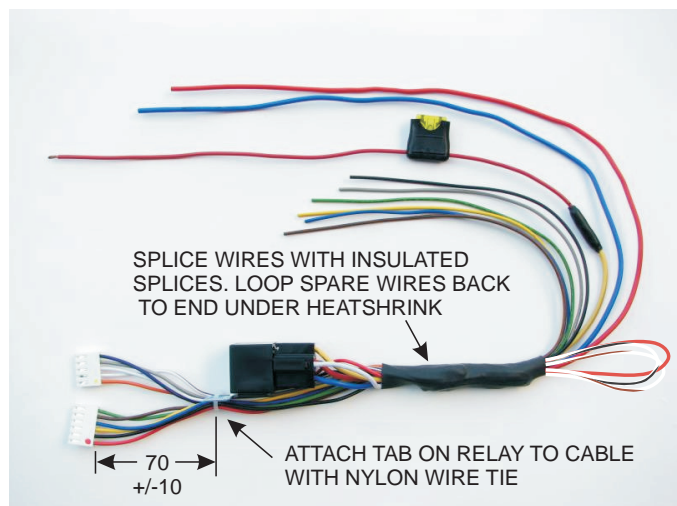

A	RELEASED					
	NO.	REVISION	ECN	BY	DATE	CHK. APP.

NOTE: TOLERANCES UNLESS OTHERWISE SPECIFIED
 FOR ANGULAR DIMENSIONS ± 0° 30'
 FOR DECIMAL DIMENSIONS X.XXX ± 0.005"
 FOR DECIMAL DIMENSIONS X.XX ± 0.010"
 FOR HOLE LOCATIONS ± 1/32"
 FOR OTHER DIMENSIONS ± 1/16"
 ARE TO BE NON-CUMULATIVE



Child Check-Mate Systems Inc.

EP2 POWER AND DOME LIGHT HARNESS

ALL OF THE INFORMATION CONTAINED ON THIS DOCUMENT IS THE EXCLUSIVE CONFIDENTIAL PROPERTY OF THE CHILD CHECK-MATE CORPORATION. THIS DOCUMENT IS DISCLOSED WITH THE UNDERSTANDING THAT IT WILL BE RETAINED IN CONFIDENCE, AND RETURNED UPON DEMAND. IT IS NOT TO BE DUPLICATED, COPIED REPRODUCED OR DELIVERED TO OTHERS, IN WHOLE OR IN PART. NOR IS THE PROPRIETARY INFORMATION CONTAINED HEREIN TO BE USED FOR ANY PURPOSE OTHER THAN THAT FOR WHICH IT IS BEING DISCLOSED.

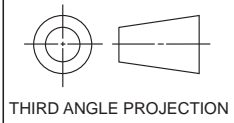

DRAWN BY:	WHT
CAD DISC FILE:	
LAST DISC REV.:	
LAST PLOT DATE:	
SCALE	PLOT SCALE

PROJ. NO.	DWG. NO.	SHEET 1 OF 1	REV. 01
-----------	----------	--------------	---------

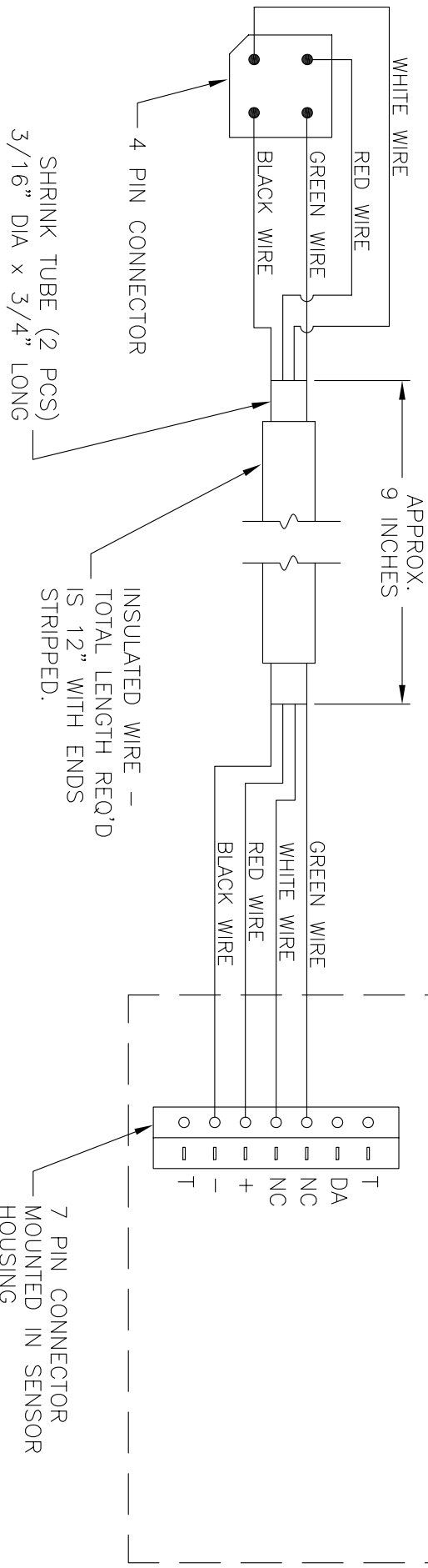

NOTE: TOLERANCES, UNLESS OTHERWISE SPECIFIED

FOR ANGULAR DIMENSIONS ± 0°30'

FOR DECIMAL DIMENSIONS XXXX ± 0.0005"

FOR DECIMAL DIMENSIONS .XXX ± 0.010"

FOR HOLE LOCATIONS ± 1/32"

FOR OTHER DIMENSIONS ARE TO BE NON-CUMULATIVE ± 1/16"

DRAWN BY: WFK 06/14/07

CAD DISC FILE: 710022_1_A

LAST DISC REV.: WFK 06/14/07

LAST PLOT DATE: WFK 06/14/07

SCALE: 12"=1'-0" PLOT SCALE: NTS

ALL OF THE INFORMATION CONTAINED ON THIS DOCUMENT IS THE EXCLUSIVE CONFIDENTIAL PROPERTY OF THE CHILD CHECK-MATE CORPORATION. THIS DOCUMENT IS DISCLOSED WITH THE UNDERSTANDING THAT IT WILL BE RETAINED IN CONFIDENCE, AND RETURNED UPON DEMAND. IT IS NOT TO BE DUPLICATED, COPIED, REPRODUCED OR DELIVERED TO OTHERS, IN WHOLE OR IN PART, NOR IS THE PROPRIETARY INFORMATION CONTAINED HEREIN TO BE USED FOR ANY PURPOSE OTHER THAN THAT FOR WHICH IT IS BEING DISCLOSED.

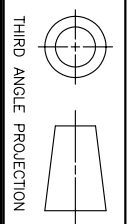

NO.	RELEASED	ECN	BY	DATE	CHK.	APP.
Δ			WFK	06/14/07	TML	AL

STOP
and check!

Child Check-Mate Systems Inc.

SCHEMATIC - WIRING
SENSOR HARNESS

PROJ. NO. .

DWG. NO. 71-0022

SHEET 1 of 1

REV. A